

Data Sheet

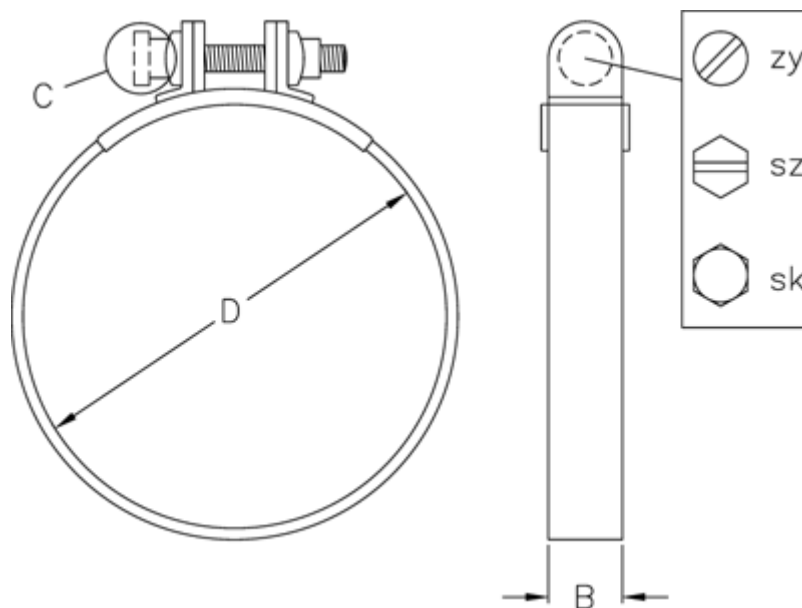

Article number: 02140000090
Description: Sealing Clamp S 90 W1

Measures



C (screw type) = SZ
Diameter D = 90
Width B = 15